

Practical Guide to Maximizing DC Measurement Performance

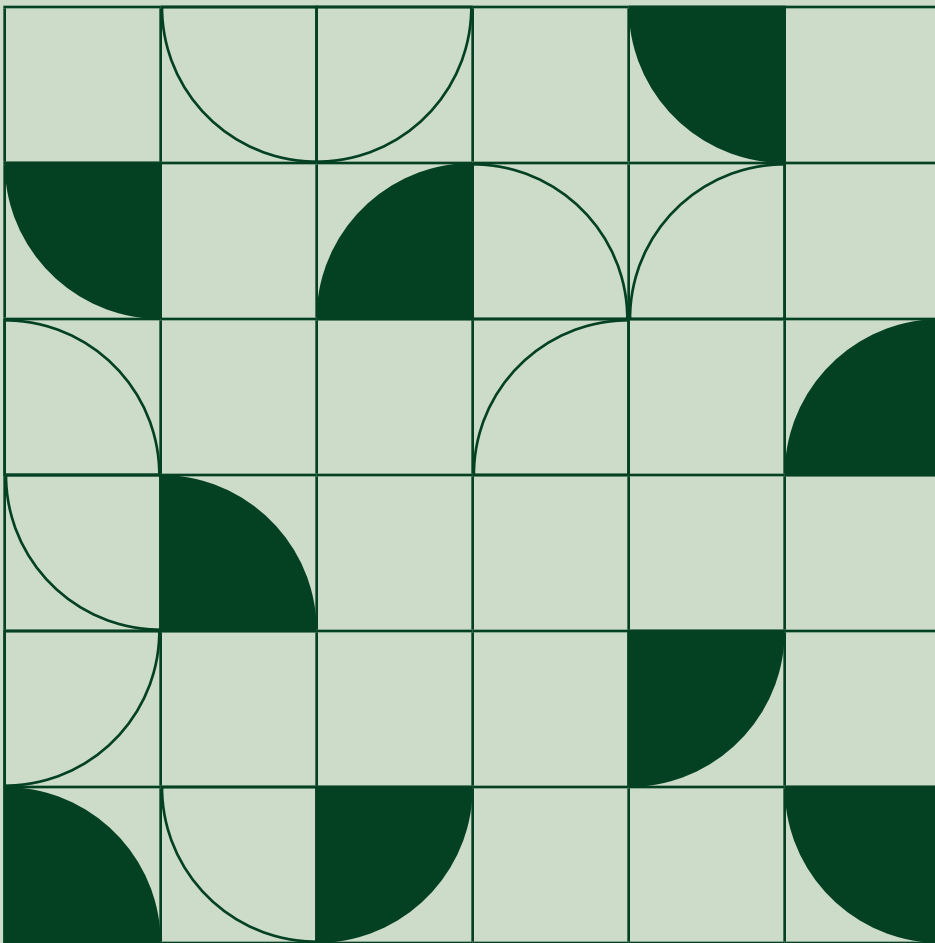

02 INTRODUCTION
SMU FUNDAMENTALS
SMU Theory of Operation

05 ACCURACY
Accuracy Versus Speed
Pulsing

10 DC MEASUREMENT
BEST PRACTICES
Use Remote Sense to Offset the
Effects of Lead Resistance
Compensate for Offset Voltage
Minimize External Noise
Guard Against Leakage Current
Understand the Importance
of Calibration

20 CONCLUSION

Introduction

Acquiring accurate DC measurements is a common need across many applications, but simply purchasing a highly accurate and sensitive instrument is not enough. Many different sources of error can affect the accuracy of your reading. Furthermore, minor adjustments to the settings on the instrument can yield different results. To achieve the highest level of accuracy, you need to thoroughly understand your instrument while using various methods to combat sources of error.

This guide shows you how to use a source measure unit (SMU) to perform DC measurements. Begin by reviewing instrument fundamentals, learning how to use SMUs, and examining the features that can help you set up your instrument. Then go over the key best practices you can apply to your test setup to mitigate various errors seen when taking DC measurements. This guide explores these best practices in the context of common measurement scenarios, so you learn when and where to most effectively apply the concepts covered.

SMU Fundamentals

An SMU is a precision power sourcing instrument that provides voltage sourcing and measurement as well as current sourcing and measurement capabilities. This control over voltage and current gives you the flexibility to calculate resistance and power through Ohm's law. These instruments offer four-quadrant output that incorporates both bipolar voltages and the ability to sink power. With all these capabilities, you may have trouble understanding how to use an SMU to make the measurements you need.

SMU Theory of Operation

A key feature of SMUs is flexibility in their four quadrant outputs (Figure 1). The output can provide positive voltage and positive current, negative voltage and positive current, negative voltage and negative current, or positive voltage and negative current. In quadrants one and three, the SMU is sourcing power, and in quadrants two and four, the SMU is sinking power. Sourcing power refers to the stimulus for a circuit and sinking power refers to the dissipating power applied by an external active component such as the output of a voltage regulator. The IV boundary shown in Figure 1 is a simplified version of an actual instrument's IV boundary. An actual SMU extends IV boundaries for pulsing mode (see "Pulsing" section).

Most SMUs can operate in either constant voltage mode or constant current mode. In constant voltage mode, the SMU acts as a voltage source that holds the voltage across the output terminals constant while current output varies. In this mode, you can set a current limit to ensure that the SMU is not driving too much current into your device under test (DUT). For example, if your SMU is connected to a 20 kΩ load and you set your current limit to 1.5 mA, you can sweep the voltage from 0 V to 20 V without reaching your current limit, as shown in Figure 2.

However, if the load is 10 kΩ, you won't be able to sweep the voltage from 0 V to 20 V without violating the current limit. You can calculate when the SMU will reach the 1.5 mA current limit using Ohm's law.

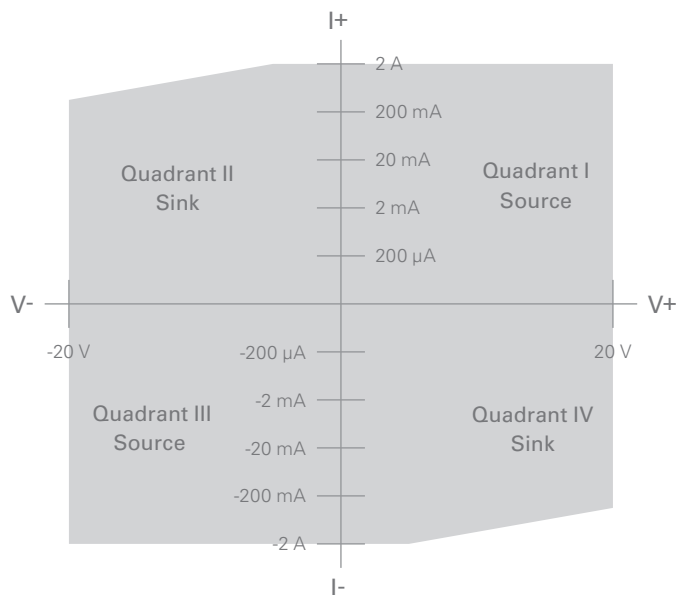

FIG 1 Simplified SMU IV operating boundary

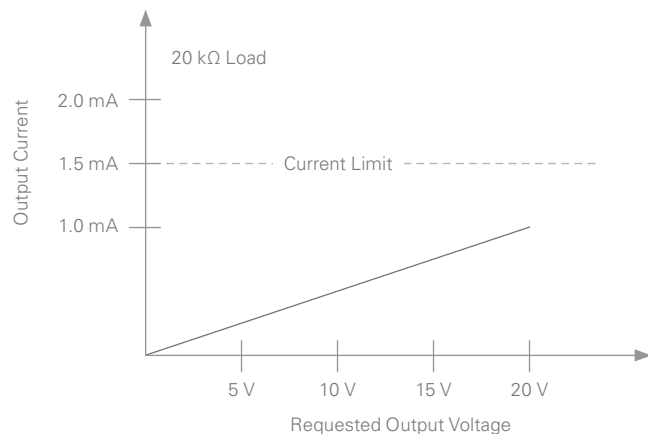

FIG 2 SMU output while operating in constant voltage mode with a current limit set to 1.5 mA for a 20 kΩ load

$$V = IR$$

$$V = 1.5 \text{ mA} * 10 \text{ k}\Omega$$

$$V = 15 \text{ V}$$

According to the calculations above, the SMU will reach the 1.5 mA current limit when the voltage output reaches 15 V. When the current limit is reached, that channel is in compliance. A channel is operating in compliance when it cannot achieve the requested output level because the programmed limit has been reached. While the SMU is operating in compliance, even if the requested output voltage is greater than 15 V, the actual output voltage does not exceed 15 V. This concept is illustrated in Figure 3. Once the SMU output reaches the 1.5 mA current limit, it is in compliance, and although the requested voltage is above 15 V, the actual voltage does not exceed 15 V. This feature is extremely useful to ensure that your SMU is not damaging your DUT by supplying too much power.

When the SMU is in constant current mode, similar principles apply. Your SMU acts as a current source and holds the current across the output terminals constant while voltage varies. In this case, you can set a voltage limit and, once the channel reaches that limit, it is in compliance.

You can apply your understanding of how SMUs work in constant voltage and constant current modes to common measurement scenarios. For example, if you're trying to measure voltage with your SMU, you can put the device in current mode and set the current level to zero while using the lowest current range possible. This allows the SMU to sense the voltage on its terminals while permitting a minimal amount of current to flow through the module; the SMU effectively acts as a high-impedance load. Similarly, if you're trying to measure current with your SMU, you should put your device in voltage mode and source zero volts while using the lowest voltage range possible; your SMU effectively acts as a short. This allows you to use the SMU like a voltmeter or ammeter.

SMU as voltmeter:

- SMU in DC current mode
- Set to lowest current range
- Source 0 A

SMU as ammeter:

- SMU in DC voltage mode
- Set to lowest voltage range
- Source 0 V

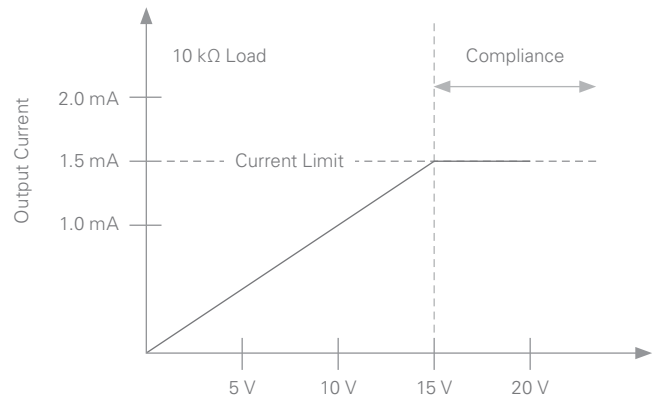

FIG 3 SMU output while operating in constant voltage showing in-compliance operation for a 10 k Ω load

Accuracy

A key difference between SMUs and power supplies is the level of accuracy that you can achieve with each. To get the most out of your SMU, you must have a good understanding of the accuracy specification and what it means. Most SMUs describe accuracy as a combination of an offset error and a gain error. Offset error refers to the difference between the actual output and the ideal output at a single point, and gain error describes the difference in slope between the actual transfer function and the ideal transfer function. These two errors are added together to determine the total accuracy specification for a given measurement. NI SMUs typically specify offset error with absolute units (mV or μA), and gain errors are specified as a percentage of the reading or requested value. This is because an offset error has the same effect no matter what value you're trying to output. But since gain error describes a difference in slope, the magnitude of the error increases as your output value increases.

Consider an example accuracy calculation using the specifications of the NI PXIe-4139 SMU to measure a 5 mA current. To make this measurement, use the 10 mA measurement range on the SMU. According to the PXIe-4139 specifications, at the 10 mA range, the SMU accuracy is 0.022 percent of reading + 200 nA. In this accuracy specification, the 0.022 percent represents the gain error and the 200 nA represents the offset error. Adding the two together gives you the complete accuracy specification.

$$\text{ACCURACY} = \text{GAIN ERROR} + \text{OFFSET ERROR}$$

$$\text{ACCURACY} = (0.022\% * 5 \text{ MA}) + 200 \text{ NA} = 1.3 \text{ MA}$$

After plugging in the value of the current reading, you see that the accuracy is 1.3 μA meaning the reading of 5 mA should be within $\pm 1.3 \mu\text{A}$ of the actual current.

A major factor that affects the accuracy of your instrument is the instrument temperature. The accuracy specification used in the previous sample calculation is valid only if the board temperature is within 1 °C of the board temperature at the completion of the last self-calibration. For example, if the board temperature was 25 °C when self-calibration was performed, the accuracy specification is valid only if the current board temperature is between 24 °C and 26 °C.

When the board temperature is within 5 °C of the self-calibration temperature, both gain and offset error increase; the accuracy specification becomes (0.03 percent of reading) + 600 nA. You can recalculate the accuracy of the 5 mA measurement using the new specification:

$$\text{ACCURACY} = (0.03\% * 5 \text{ mA}) + 600 \text{ nA} = 2.1 \mu\text{A}$$

After plugging in the value of the current reading, you see that the accuracy is 1.3 μA meaning the reading of 5 mA should be within $\pm 1.3 \mu\text{A}$ of the actual current.

A major factor that affects the accuracy of your instrument is the instrument temperature. The accuracy specification used in the previous sample calculation is valid only if the board temperature is within 1 °C of the board temperature at the completion of the last self-calibration. For example, if the board temperature was 25 °C when self-calibration was performed, the accuracy specification is valid only if the current board temperature is between 24 °C and 26 °C.

When the board temperature is within 5 °C of the self-calibration temperature, both gain and offset error increase; the accuracy specification becomes (0.03 percent of reading) + 600 nA. You can recalculate the accuracy of the 5 mA measurement using the new specification:

$$\text{ACCURACY} = (0.03\% * 5 \text{ MA}) + 600 \text{ NA} = 2.1 \text{ MA}$$

This slight difference in temperature decreased the instrument accuracy by 0.8 μA . When making low-level current or voltage measurements, you should periodically perform self-calibration to correct for these temperature effects (see "Calibration" section).

Accuracy Versus Speed

You determine measurement speed for an SMU using the aperture time. Aperture time is the period during which an analog-to-digital converter (ADC) reads the voltage or current on an SMU. In Figure 4, the aperture time determines how long the measure period lasts. By varying the aperture time of the instrument, you have the flexibility to extend the acquisition window for high-precision measurements or decrease the window for high-speed acquisitions. Extending the measurement aperture gives the instrument more time to sample and average, which reduces the noise of the measurement.



FIG 4 Illustration of the aperture time of an SMU with respect to a sample signal

SMU specifications provide quantitative data on how aperture time affects measurement noise. For reference, the PXIe-4139 SMU aperture time versus measurement noise graph is shown in Figure 5. As you can see, the noise levels decrease significantly as you increase the aperture time. In addition, the noise level is higher at higher voltage ranges. If your application requires low-voltage or low-current measurements, you should set the instrument to use the lowest measurement range possible.

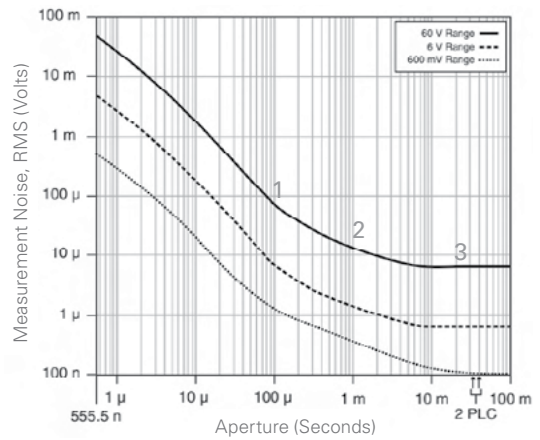

FIG 5 Voltage measurement noise versus measurement aperture

The actual noise performance of the PXIe-4139 SMU using 60 V range at three different aperture settings is shown in Figure 6. In the first section of the graph, the aperture time was set to 100 μ s. As you can see, the noise is high when the aperture time is low. In the second section, the aperture time was set to 1 ms, which greatly reduced the noise in the reading. In the final section, the aperture time was set to 16.7 ms, which is one power line cycle. At this setting, the noise is minor and barely noticeable.

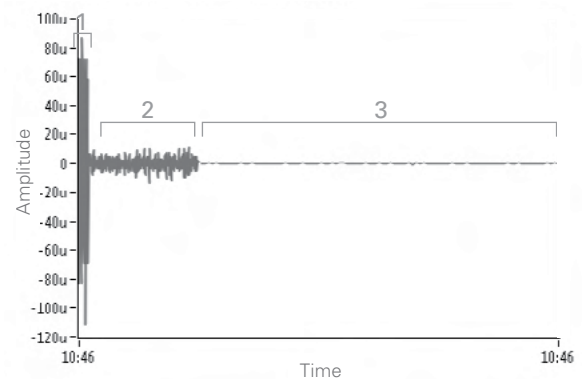

FIG 6 PXIe-4139 noise performance at various measurement aperture times

A common best practice is to set your aperture time to whole number multiples of a power line cycle. In countries that have a grid power frequency of 60 Hz, one power line cycle equals 16.67 ms, but in countries with a 50 Hz grid, one power line cycle equals 20 ms. When you sample over multiple power line cycles, 60 Hz or 50 Hz noise is averaged out from your DC measurement.

In many applications, you need to optimize test time, which means minimizing aperture time. However, a low aperture time could introduce additional noise into the measurement and limit your reading's accuracy. On the flip side, if you are trying to examine the transient response of a load and accuracy is not your main concern, you can use short aperture times to digitize the signal with your SMU. For example, the PXIe-4139 SMU

can sample up to 1.8 MS/s. This gives you the ability to observe the detailed transient characteristics of your signal. Be sure to keep in mind the trade-off between speed and accuracy when developing your application.

Pulsing

Another useful feature of many SMUs is pulsing. You can use pulsing to go beyond the maximum power level your instrument can provide for a short period of time. Because of this, the IV boundary of the SMU is different when using pulse mode versus DC mode (see the more detailed IV boundary graph shown in Figure 7).

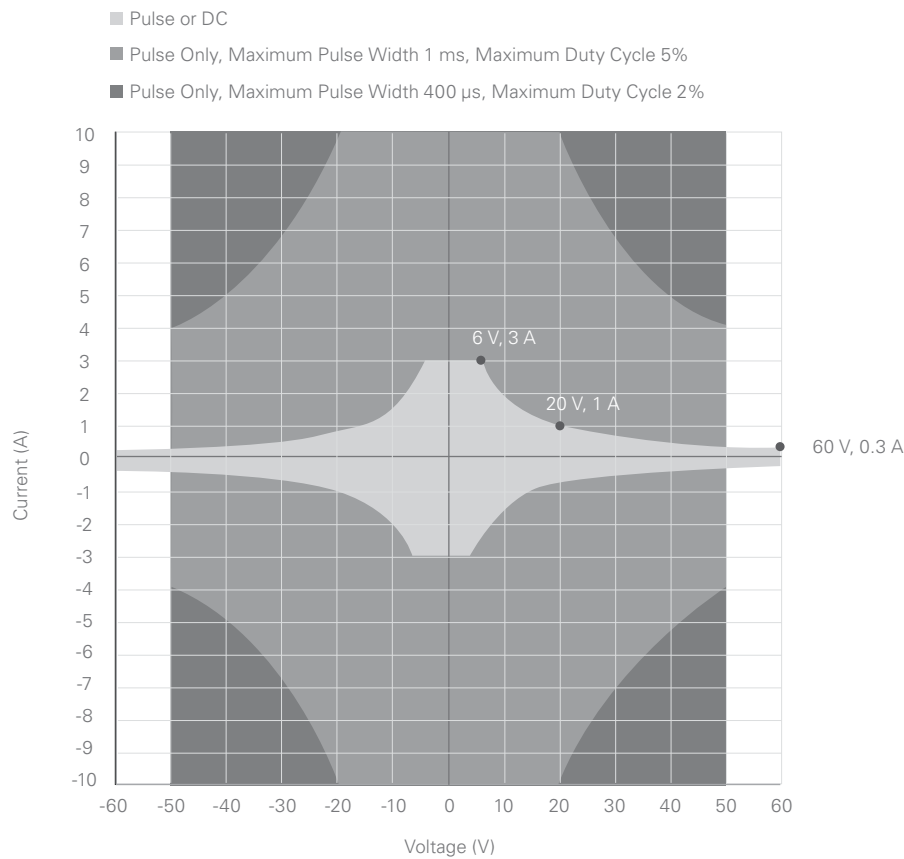

FIG 7 | Sample SMU IV boundary with pulsing

With our new platform based on [PXI], we've maintained both measurement and performance integrity while achieving 3X cost reduction and 10X improvement in semiconductor validation throughput.

Ray Morgan
Product Line Manager, ON Semiconductor

SMUs capable of pulsing have a unique output architecture to achieve power above the rated DC boundary. They have internal capacitors that are charged when the device is not sourcing. When the device outputs a pulse, the capacitors discharge to provide power beyond the standard specifications. Because these SMUs are temporarily outputting more power than they draw from their power supply, they are limited in how fast and for how long they can output at that power. Restrictions on key pulsing specifications ensure that the SMU can consistently output the desired power without overheating from sinking too much power. These specifications include duty cycle, maximum power, maximum pulse on-time, minimum pulse on-time, and minimum pulse cycle.

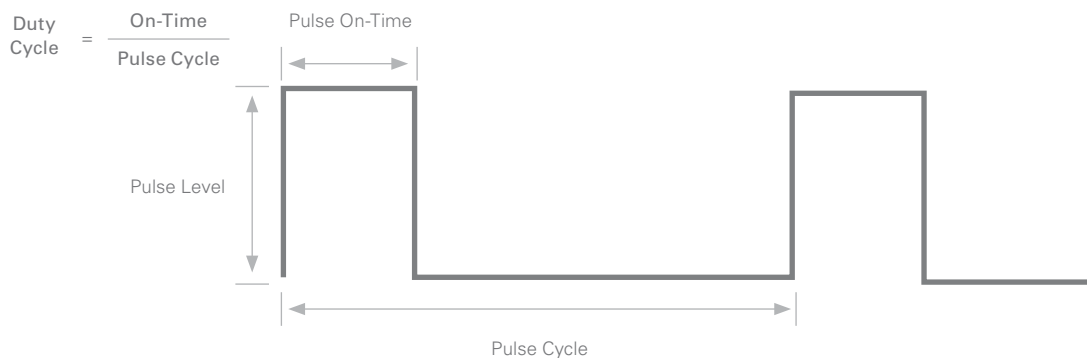

FIG 8 | Key SMU pulsing specifications

Pulsing is commonly used to limit the heat the DUT has to dissipate during high-powered tests. If a constant high-powered DC signal is provided to the DUT, the temperature in the DUT increases, and this change in temperature can cause changes in the electrical and physical properties of the DUT. If the temperature changes are dramatic enough, they affect your measurement or even damage the DUT. But by pulsing power, you can reduce the average power dissipation through the DUT and minimize the effects of self-heating.

Another consideration when using pulse mode is the transient response of the SMU. When testing in pulse mode, the pulse width should be long enough for the instrument to take a settled measurement but short enough to minimize self-heating to the DUT. To achieve this, you need to make sure that the transient response is critically damped. When you have an under-damped response, like in Figure 9, the output overshoots or becomes unstable, which does not provide a good measurement and can even damage your DUT. If you have an over-damped response, like in Figure 10, the pulse does not reach the desired output level fast enough. When the response is critically damped, like in Figure 11, the signal settles quickly and gives you time to measure the pulse. To ensure the SMU generates a clean pulse, you need to digitize the transient response with an instrument that can sample fast enough. Some SMUs like the PXle-4139 have this capability, but if your SMU does not, you need to use an oscilloscope.

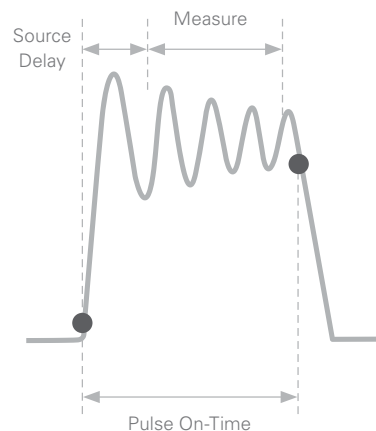

FIG 9 Under-damped transient response

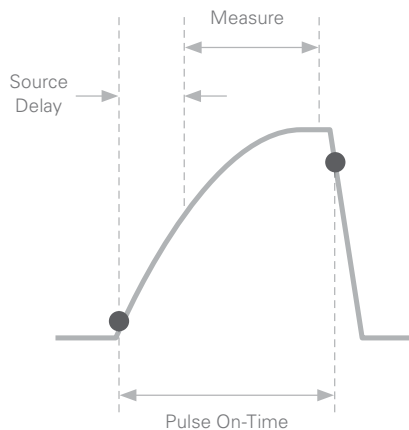

FIG 10 Over-damped transient response

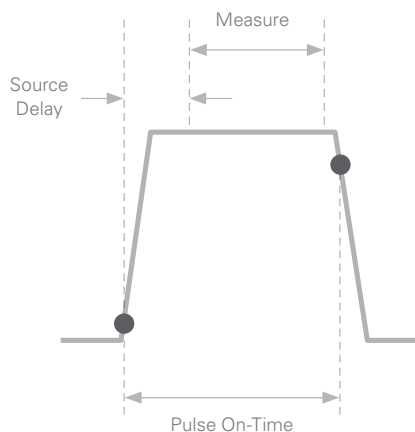

FIG 11 Critically damped transient response

DC Measurement Best Practices

Beyond the SMU instrument itself, the test setup is a key factor that affects your measurement. The instrumentation cannot make up for poor signal quality. To make a high-accuracy DC measurement, you need a high-fidelity signal. If your signal of interest includes a lot of noise, you can't get an accurate measurement even with a high-quality instrument. Many different sources of noise and error can affect your signal, but this white paper includes a variety of methods to help you deal with these issues. Since different types of measurements are susceptible to different types of errors, you also need to know when and how to apply each method. The methods discussed in this section apply to DC measurements made by all types of instruments, not just SMUs. However, since this guide focuses on SMUs, many of the examples used feature this instrument. Combining the best practices in this section with the instrument information in the previous section gives you a holistic understanding of how to make a high-accuracy DC measurement.

Use Remote Sense to Offset the Effects of Lead Resistance

Remote sense is a method used to remove the effects of lead resistance on your measurement. In a standard 2-wire setup, if you set your power supply to source 5 V, the DUT sees a voltage slightly less than 5 V because the voltage potential drops due to lead resistance. For example, a 3 m long, 24 AWG copper wire has a resistance of about 0.25 Ω . If you are sourcing 5 V and 1 A from the SMU, the voltage potential drops 0.25 V throughout the length of that wire. Remote sense eliminates this effect to ensure that the DUT sees exactly 5 V.

Remote sense uses a 4-wire setup that includes a set of high-impedance sense lines. During remote sense, one set of leads carries the output current while another set of leads measures

voltage directly at the DUT terminals. In Figure 12, the HI and LO lines carry the output current, and the Sense HI and Sense LO lines measure the voltage directly at the DUT terminals. A significant amount of current flowing through the output leads results in a larger voltage drop through the lead wires, but the high-impedance sense lines have a negligible amount of current flowing through them, which results in negligible voltage drop due to lead resistance. Using the sense lines and the SMU, you can maintain your desired output voltage at the sense leads by increasing the voltage at the output to compensate for voltage drop due to lead resistance. This means that you supply your DUT with a voltage closer to what you actually defined.

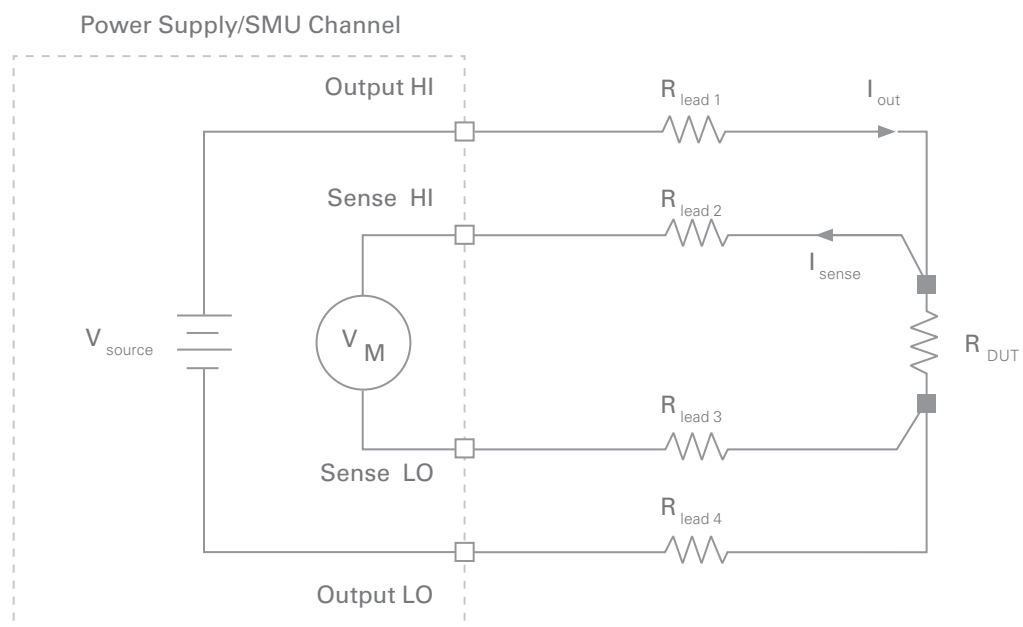

FIG 12 | 4-Wire remote sense measurement setup

The single setup as opposed to the traditional benchtop equivalent (Keithley and Agilent) saves an estimated \$20,000. This cost savings comes from the modules, space and energy, and development.

Junifer B. Frenila
Product Engineer, Analog Devices

Devices with remote sense capabilities have additional specifications on how to calculate accuracy when using remote sense. To better understand how to calculate this accuracy, consider an example using the specifications of the PXIe-4139 SMU. In this example, you calculate the remote sense accuracy of a 500 mV output using the 600 mV range on the SMU. Table 1 shows additional setup properties.

The accuracy of the SMU when using the 600 mV range is 0.016 percent + 30 μ V.

HI path lead drop	3 V
HI sense lead resistance	2 Ω
LO path lead drop	2.5 V
LO sense lead resistance	1.5 Ω

TBL
1 | Table Info : Properties of remote sense measurement setup

The remote sense voltage accuracy specification for this instrument states:

“ADD (3 ppm OF VOLTAGE RANGE + 11 μ V) PER VOLT OF HI LEAD DROP PLUS 1 μ V PER VOLT OF LEAD DROP PER Ω OF CORRESPONDING SENSE LEAD RESISTANCE TO VOLTAGE ACCURACY SPECIFICATIONS.”

You can calculate the remote sense accuracy with the following formula:

$$\begin{aligned}
 & \text{ACCURACY} = (\text{SMU ACCURACY, RANGE}=600 \text{ mV}) + \text{ERROR DUE TO LEAD VOLTAGE DROP} + \\
 & \quad \text{ERROR DUE TO LEAD VOLTAGE DROP PER LEAD RESISTANCE} \\
 \text{ACCURACY} &= (500 \text{ mV} * 0.016\% + 30 \mu\text{V}) + \frac{600 \text{ mV} * 3 \text{ ppm} + 11 \mu\text{V}}{1 \text{ V OF LEAD DROP}} * 3 \text{ V} + \frac{1 \mu\text{V}}{\text{V} * \Omega} \\
 & \quad * 3 \text{ V} * 2 \Omega + \frac{1 \mu\text{V}}{\text{V} * \Omega} * 2.5 \text{ V} * 1.5 \Omega \\
 \text{ACCURACY} &= (80 \mu\text{V} + 30 \mu\text{V}) + 12.8 \mu\text{V} * 3 + 6 \mu\text{V} + 3.8 \mu\text{V} \\
 \text{ACCURACY} &= 158.2 \mu\text{V}
 \end{aligned}$$

This means the actual output is within 158.2 μV of 500 mV. In the calculation above, the portion in the parentheses represents the accuracy of the SMU when using the 600 mV range. The rest of the formula represents the remote sense voltage accuracy specification.

When using remote sense, you should connect the sense lines as close to the DUT as possible. This gives the sense lines an accurate reading of the voltage at the DUT. However, sometimes you cannot directly connect the sense lines to the DUT; for example, if the DUT is in an area of the board that cannot be directly probed. When this occurs, the voltage provided at the remote sense connections is accurate, but the additional resistance between where remote sense is connected and the actual DUT causes a voltage drop. To ensure the DUT sees an accurate voltage level, you can use some SMUs to configure a negative output resistance. To nullify the unwanted voltage drop, you can program the negative output resistance to be equal to the path resistance between the remote sense connection and the DUT. This allows your instrument to provide an accurate voltage to your DUT even if remote sense lines cannot be directly connected to your DUT.

Remote sense is especially helpful for low-resistance measurements. You can use both SMUs and digital multimeters (DMMs) to make resistance measurements by sourcing current

and measuring the voltage to calculate resistance. When taking precision resistance measurements below 100 k Ω , you need to use a 4-wire remote sense setup instead of a 2-wire setup to minimize the effects of lead resistance. Earlier, you learned how lead resistance affects voltage measurements when using the 2-wire method. Since you calculate resistance measurement from the voltage measurement, inaccurate voltage readings lead to inaccurate resistance readings. By using the 4-wire method, you eliminate the effects of lead resistance to generate a more accurate measurement.

Table 2 shows the difference that remote sense can make in your measurement. This data is generated with a DMM measuring a resistor through a switch. The lead resistance from the switch added 0.522 Ω to the measurement, which represents a 5.24 percent error. When you use remote sense, you eliminate the error from lead resistance and receive a more accurate reading.

When using remote sense, keep in mind the limitations of your instrument. SMUs and DMMs have a maximum level of voltage drop they can manage. For example, the PXIe-4139 can compensate for a maximum lead drop of 3 V per lead. This means that the device can compensate for a 3 V drop on the HI side and another 3 V drop on the LO side. Once that limit is reached, the instrument can no longer fully compensate for the lead resistance. The lead resistance that is not compensated for degrades the accuracy of your measurement.

Compensating for Lead Resistance Using Remote Sense

ACTUAL RESISTANCE	MEASUREMENT WITHOUT REMOTE SENSE	MEASUREMENT WITH REMOTE SENSE
9.958 Ω	10.48 Ω	9.958 Ω

TBL 2 | The difference remote sense can make in measurement

Compensate for Offset Voltage

For low-voltage measurements, you need to eliminate the effects of offset voltages. One common source of offset voltage is thermal EMF. In thermal EMF, an error voltage is introduced into a circuit due to the formation of a thermocouple between leads made of dissimilar metals. For example, if you have a setup that pairs switches with SMUs to make measurements, the switches are a source of thermal EMF error due to the different contacts that exist in the signal path. Switch specifications often include thermal EMF. The NI PXI-2530 matrix switch uses reed relays and has a thermal EMF of <math><50 \mu\text{V}</math>. If your measurement is in the millivolt range or lower, the thermal EMF from that switch causes significant error.

Offset compensation is one method you can use to cancel out the effects of thermal EMF. To implement offset compensation with an SMU, you need to program the device to take two measurements. These measurements are illustrated in Figure 13. In the first measurement cycle, the SMU current source is on and the voltage measurement includes thermal EMF. In the second measurement cycle, the SMU current source is off, which means it measures only the voltage induced by thermal EMF. You can now subtract the second measurement from the first to get an accurate measurement that does not include the effects of thermal EMF.

The next formula shows how you make the calculation. In this formula, V_{OC} represents the voltage after offset compensation is applied. V_{M1} is the voltage measurement with the current source on and V_{M2} is the voltage measurement with the current source off. I_S represents the current from the SMU current source, and R_X represents the resistance of the load. Finally, $V_{thermal}$ is the offset voltage caused by thermal EMF.

$$V_{OC} = V_{M1} - V_{M2} = (I_S R_X + V_{thermal}) - V_{thermal} = I_S R_X$$

Both measurements include the thermal EMF offset, $V_{thermal}$. Because the offset voltage is present in both measurements, subtracting the second measurement from the first eliminates this offset.

Another way to eliminate offset voltage is the current reversal method. Like the offset compensation method, you need two measurements for the current reversal method. You make the first measurement with a positive current and the second measurement with a negative current. The mathematical representation of these measurements is shown on the next page.

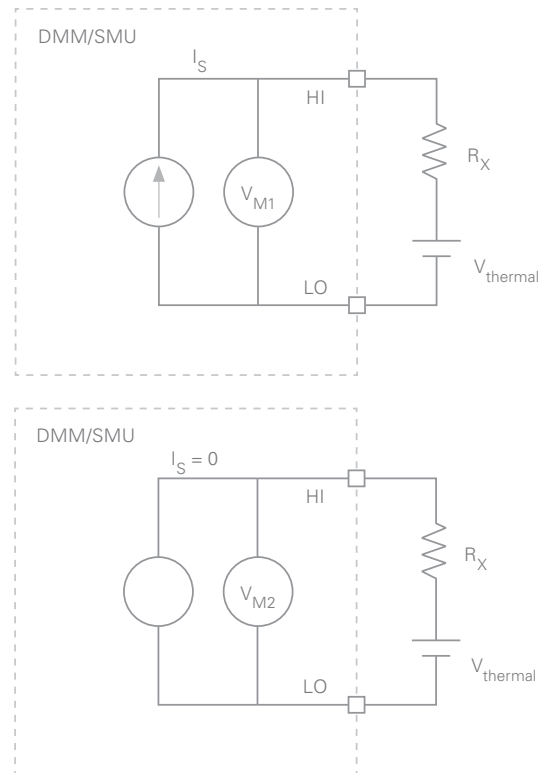

FIG 13 Offset compensation measurement cycles

$$V_{M1} = I_S R_X + V_{\text{thermal}}$$

$$V_{M2} = -I_S R_X + V_{\text{thermal}}$$

Again, since both measurements include V_{thermal} , you can eliminate this offset by combining the two measurements as shown below.

$$V_{CR} = \frac{V_{M1} - V_{M2}}{2} = \frac{(I_S R_X + V_{\text{thermal}}) - (-I_S R_X + V_{\text{thermal}})}{2} = I_S R_X$$

One advantage of the current reversal method is that it provides a higher accuracy measurement than the offset compensation method. This is because two measurements are averaged together to produce the final measurement. The drawback to this method is that you must have a device capable of sourcing positive and negative current whereas the offset compensation method requires only positive current.

Minimize External Noise

When taking sensitive measurements, you need to consider the effects of noise on your readings. Noise can come from several sources, such as electromagnetic interference or parasitic capacitance. Electromagnetic interference encompasses interference from a wide range of frequencies across the spectrum. TV, AM/FM radio, and power lines can all be sources

of electromagnetic interference. Parasitic capacitance occurs when an electrically charged object is close to the measurement circuit. When two electrical conductors at different voltages are close together, the electric field between them causes electric charge to be stored on them. This can show up as an oscillating noise or an offset to your measurement. By using shielding, you can reduce the effects of the electric field and minimize error in your measurement.

Shielding is the practice of reducing the electromagnetic field in a space by blocking the field with barriers made of conductive materials. In practice, you should apply shielding to the entire measurement circuit, so you should shield both the DUT and the cables used to connect the DUT. Faraday cages and shielded cables are widely available and can be used to shield the area around the DUT along with the leads. Coaxial cables are a common type of shielded cable. Their core is enclosed in an insulating layer that is surrounded by the shield. The outer shield protects the inner core from electrical noise (see Figure 14). As you can see, the shield is connected to the LO terminal of the instrument. Because of this, any electromagnetic interference or parasitic capacitance picked up by the shield flows to the ground rather than the HI terminal of the instrument. You can address the parasitic capacitance between the HI and LO terminals by adding a guard layer to the cable (see the “[Guard Against Leakage Current](#)” section). If the LO terminal of the instrument is floating above the ground, you should add another cage around the test setup so operators do not accidentally touch the shield.

 We successfully converted a lengthy manual test process into a highly automated test cycle and reduced the regression test cycle from weeks to days while increasing reliability, repeatability, and maintainability.

Sambit Panigrahi
System Integration and Tools Lead, Texas Instruments



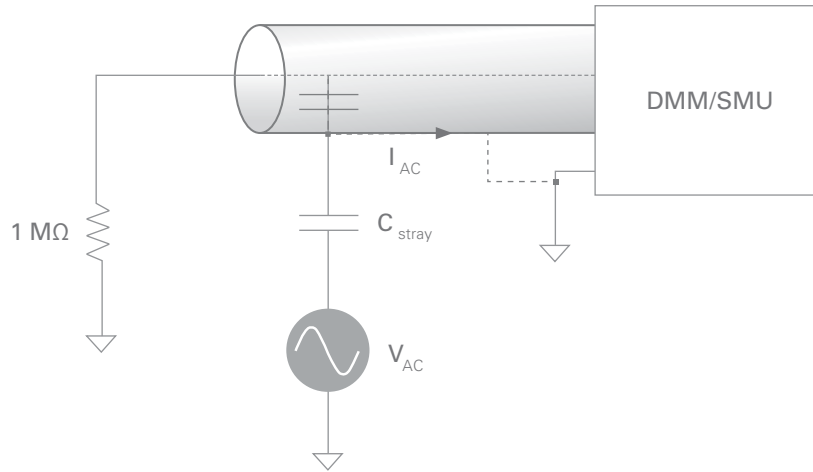

FIG 14 Circuit diagram illustrating how shielding reduces the electromagnetic field in a space by blocking the field with barriers made of conductive materials

Shielding is especially helpful for high-impedance measurements. In Figure 14, you can see that I_{AC} is the current induced by the noise source, V_{AC} . If you don't use shielding, that induced current appears in your measurement circuit. If you are making a high-resistance measurement, the effects of the induced current are magnified. According to Ohm's law, if resistance is high, I_{AC} causes a larger voltage error in the measurement. Therefore, shielding is important when working with a high-resistance DUT.

When connecting a DUT to your instrument using a shielded cable, you should connect the shield to either the instrument

ground or the DUT ground but never both at the same time. This is to avoid creating ground loops in your measurement setup. A ground loop occurs when a system has two points of ground reference but they are at different voltage potentials. This causes current to flow between the two ground references, which affects your measurement. If the DUT is grounded and the shield of the cable is connected to both the DUT ground and the instrument ground, a ground loop could be formed. By connecting the shield at only one end, you can eliminate this potential issue.

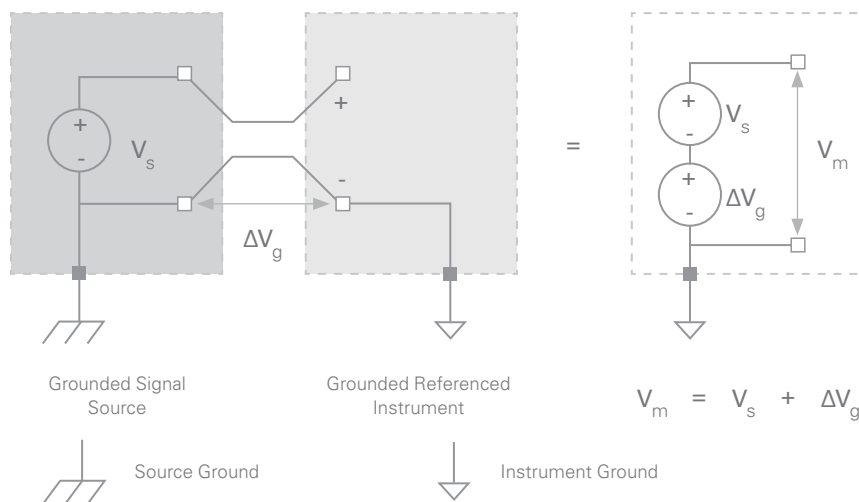

FIG 15 A grounded signal source measured with a ground-referenced system introduces ground loops and measurement error.

Another possible source of external noise is magnetic fields. The amount of voltage a magnetic field induces in a circuit is proportional to the area the circuit encloses. If your measurement leads create a big loop in the circuit, your setup is more susceptible to magnetic induced noise. A simple and popular fix is to use twisted pair cables instead. With a twisted pair cable, the leads are twisted together, which reduces the area the circuit encloses and makes your setup less susceptible to magnetic noise. You can add shielding around the twisted pair cable to protect the leads from external electromagnetic noise.

Guard Against Leakage Current

Though shielding prevents external electromagnetic interference from affecting the measurement, guarding protects against leakage current and parasitic capacitance between the shield and the measurement circuit. When using a cable without guarding, like a coaxial cable, the cable insulation is parallel to the load, which causes leakage current to flow between the HI and LO terminals. In Figure 16, I_L represents the leakage current flowing between HI and LO. This means the current measured by the SMU device is a sum of the load current, I_{Load} , and the leakage current, I_L .

Guarding is especially important when making low and ultra-low current measurements. To illustrate this, calculate how much leakage current can affect your measurement when using a coaxial cable to source 50 V. In a coaxial cable, a layer of insulation separates the inner core and the outer shield. Ideally, the insulation has infinite resistance, but in reality the resistance is finite. The insulation resistance is different for every coaxial cable, but assume that the resistance of a given cable is 100 GΩ. You can calculate the leakage current through the insulation.

$$I_L = \frac{50 \text{ V}}{100 \text{ G}\Omega} = 0.5 \text{ nA}$$

Based on this calculation, if your application requires femto-amp measurements, you cannot use a coaxial cable. In addition, as the voltage level increases, the amount of leakage current increases as well.

To make these low-level current measurements, you should use a triaxial cable instead. Figure 18 shows a diagram of a triaxial cable. Triaxial cables have an additional layer of conducting sheath, called the guard, between the core of the cable and the shield.

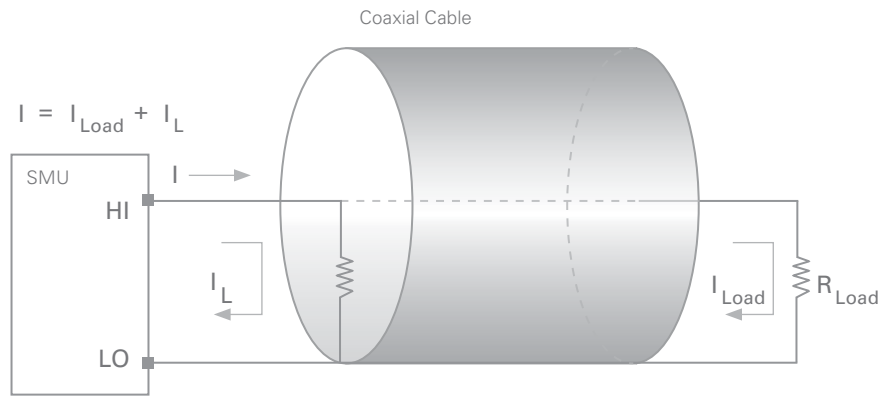

FIG 16 Leakage current in coaxial cables

This middle layer is connected to the guard terminal of the SMU. Guard terminals on SMUs are driven by a unity gain buffer that follows the voltage of the HI terminal. The unity gain buffer is a negative feedback op-amp (see Figure 17) where the output of the op-amp, V_{out} , is connected to its own negative input terminal. When you tie the positive input terminal of the op-amp, V_{in} , to the HI terminal of the SMU, the output voltage of the op-amp matches the voltage of the HI terminal on the SMU.

Since the guard layer of a triaxial cable is connected to this unity gain buffer, the guard layer is at the same voltage potential as the HI terminal, and there's effectively a 0 V drop between the HI terminal and the guard terminal (see Figure 18). With no difference in voltage potential, leakage current does not flow between the HI and the guard. Some leakage current, I_{Guard} , still flows from the guard output to LO, but since the current is supplied by the unity gain buffer instead of HI, this leakage does not affect the output or measurement. As a result, a triaxial cable eliminates the effects of leakage current and provides more accurate current measurements.

Using a guard also reduces the parasitic capacitance between the HI and LO terminals of the SMU. When two electrical conductors at different voltage potentials are close together,

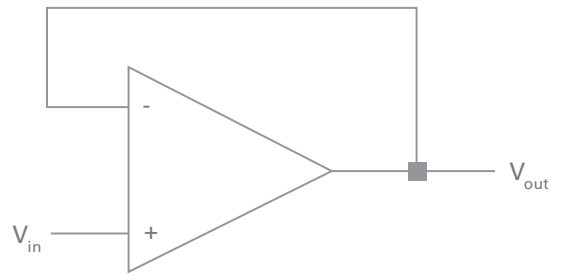

FIG 17 Unity gain buffer

the electric field between them causes an electric charge to be stored on them. This effect is parasitic capacitance. In the case of a coaxial cable, the inner core (HI) is close to the outer shield (LO), which results in parasitic capacitance. Since there's a large difference in voltage potential between the HI and the LO, the capacitance takes more time to charge, which means the signal takes longer to settle. When you use guarding, the capacitance between HI and guard doesn't have to charge as extensively since they're at the same voltage potential. This reduces the settling time of the signal.

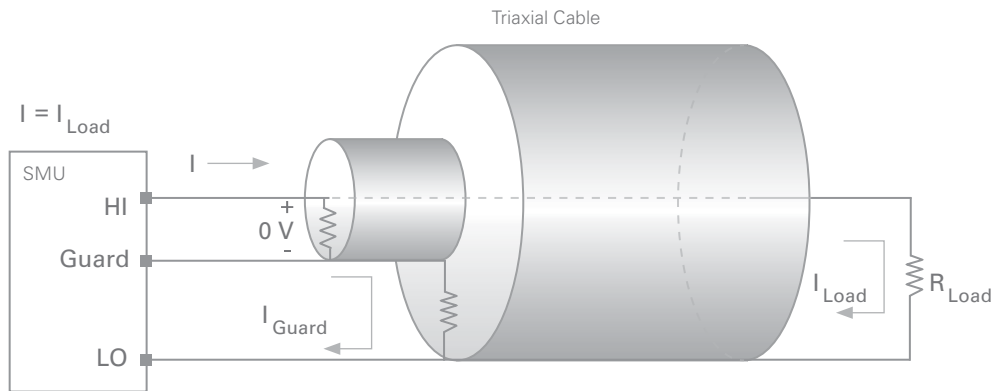

FIG 18 Effects of using guarding

One common application that requires the use of guarding is input leakage test. You perform input leakage tests by measuring the amount of current that flows into a high-impedance input pin on a chip. An ideal input pin has infinite impedance, which results in no current flow. However, real-world DUTs have large but finite impedance, which results in a small current flow typically on the order of microamps or lower. This test is commonly conducted with an SMU because you can source voltage and measure current at the same time.

Since this is a low-level current measurement, you should use the guard lines on the SMU to ensure the most accurate measurement possible. Once you connect the DUT to the SMU, you should set the SMU to source voltage. You should also set a current limit to protect the DUT from being damaged. As it sources voltage, the SMU measures the current leakage from the DUT. You can then compare the leakage current value with the acceptable limits for that DUT to see if the DUT is within specifications. Make sure that you're not also measuring the current leakage between the HI and LO terminal of the SMU. If you use a coaxial cable in this application, the leakage current from the cable is added to the measurement and can cause a DUT to fail the test when the actual DUT leakage current is within specifications. By using a triaxial cable and the guard on the SMU, you can get a more accurate current measurement and ensure that DUTs are not failed unintentionally.

Understand the Importance of Calibration

You need calibration to ensure that your instrument performs at the level stated in the specifications. The two main forms of calibration are external calibration and self-calibration. You can use external calibration to correct for drift on the instrument and self-calibration to correct for temperature-induced errors.

External calibration, the more complicated procedure, requires highly precise voltage sources. When an external calibration is performed, the instrument's onboard EEPROM calibration constants are adjusted and overwritten. These constants are used by the device drivers to return the appropriate values for a given measurement. External calibration is mainly used to correct long-term drift in onboard references or offsets that self-calibration cannot access. To maintain the published specifications of an instrument, external calibration is recommended every one to two years, depending on the instrument.

Self-calibration is a much simpler process that you can perform without any additional equipment. This procedure involves routing a known internal reference to all channels of the board. The reference voltage is then read at various gain settings and compared to the expected value. This temperature-protected reference voltage is meant to correct errors caused by temperature changes. Because the properties of components depend on the operating temperature, you should use self-calibration to compensate for temperature changes and ensure that your instrument is as accurate as possible.



Adopting the PXI platform and setting up global PXI champions across our R&D sites to create a standard validation practice around the globe [increased] our test coverage to improve analysis and quality compared to rack-and-stack and benchtop instrumentation.

Christian Paintz
Characterization Competency Center Manager, Melexis GmbH



The graphs shown in figures 19, 20, and 21 illustrate the difference self-calibration can make. These graphs were made by putting several devices in a temperature chamber and monitoring their performance. Figure 19 shows how the temperature of the boards changed over a 24-hour period. Figure 20 shows how the offset voltage level changed over that same period. Higher temperatures caused a slight positive voltage offset, and lower temperatures resulted in negative voltage offset. However, if you use

self-calibration before taking each measurement, you eliminate the voltage offset due to temperature, and it does not affect your measurement (see Figure 21).

Remember that self-calibration is only as accurate as the accuracy of the onboard reference voltages. Because of this, you need to perform external calibration on your instrument at the manufacturer-recommended intervals to ensure that the reference voltages are within specifications.

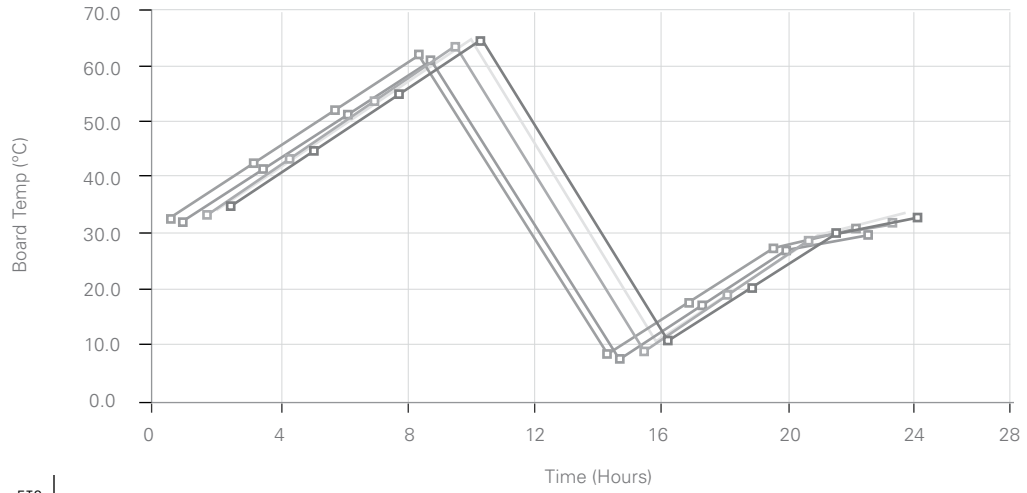

FIG 19 Test board temperature over a 24-hour period

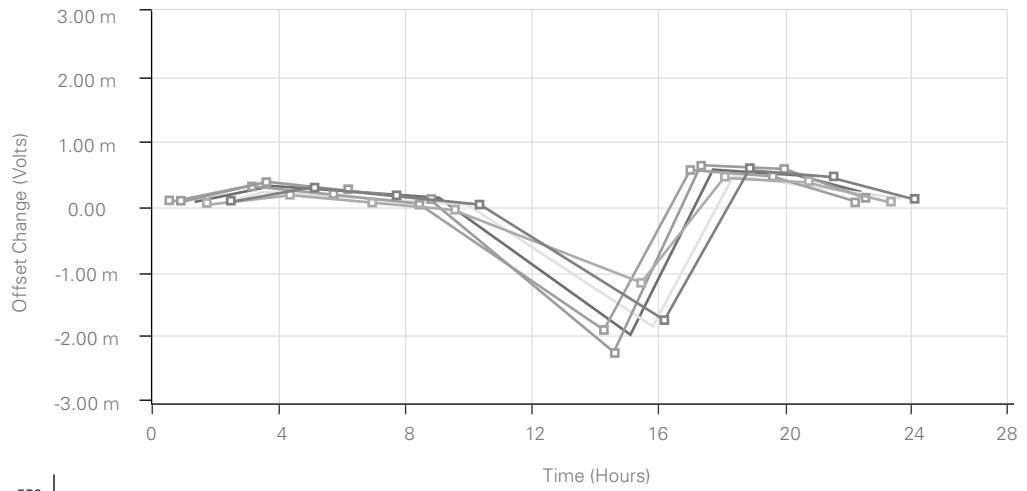

FIG 20 Voltage drift without self-calibration

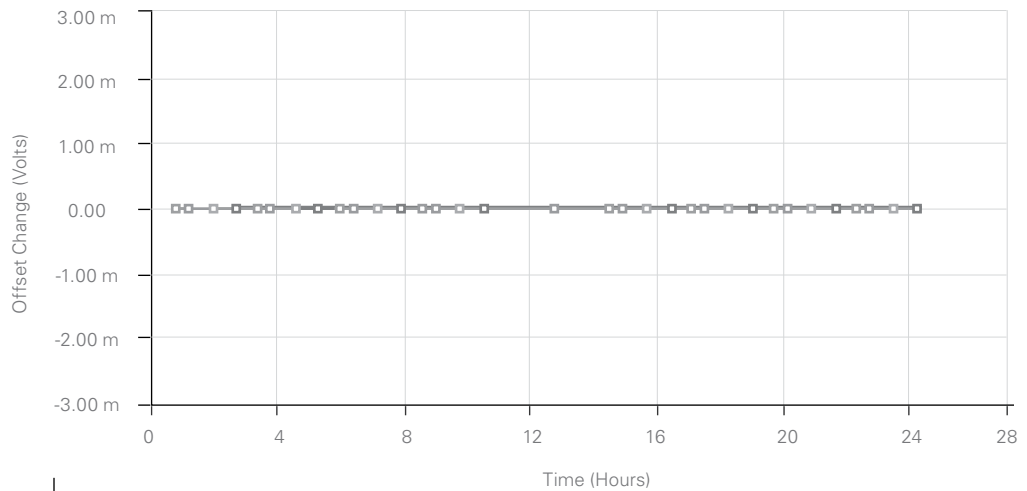

FIG 21 Voltage drift with self-calibration



Conclusion

The various methods covered in this guide can help you achieve greater accuracy in your applications requiring DC measurements. When applying these methods to your own measurement setup, remember what kind of error each method is designed to address. This allows you to apply the right solution to the measurement issue you're experiencing. For example, if you're seeing slow rise times in your low-level current measurement, switching to triaxial cables and adding guarding could help. If you're seeing power line noise, you can add shielding to your setup and set the aperture time to one power line cycle. Mastering these best practices helps you get the most out of your test equipment.

To learn more about NI SMUs and their custom transient response or advanced sequencing features, visit ni.com/smu.

Our validation gauntlet is a growing collection of highly automated bench platforms that we put all our products through to look for any last remaining weaknesses before we put them in the hands of our customers. Each of the platforms must be fast and flexible yet low in cost so they can easily scale across the company as needed, which is why you'll find PXI at the heart of many of these platforms.

Marvin Landrum
Validation Infrastructure Manager, Texas Instruments

